

BIG WHITE[®]

EVOLUTIONS

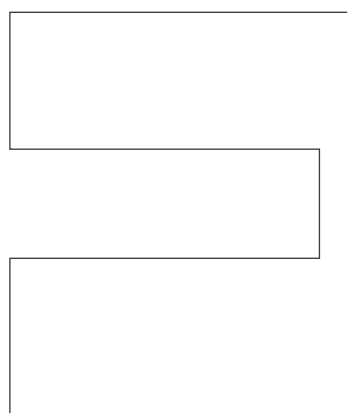



WELL INFORMED

Stay up to date and always receive our latest prices.
Scan the QR code now and visit us at **slv.com**
or one of our partner websites.

BIG WHITE®

EVOLUTIONS





 PANTILO
20







Light is versatile and influences all areas of our lives.
Just as versatile are the possibilities with SLV to
make lighting and thus light a unique experience.

EXPERIENCE LIGHT.

| | |
|---------------------|----|
| M-POL | 12 |
| UNIVERSAL DOWNLIGHT | 16 |
| PANTILO | 20 |
| ENOLA OCULUS | 22 |
| MANA | 24 |
| CONCRETO | 28 |
| VANO WING | 30 |
| ESKINA FRAME | 32 |
| OCULUS | 36 |
| S-TRACK | 38 |
| WORKLIGHT | 44 |
| PARA DOME | 48 |
| FITU | 49 |
| FLOODI | 49 |



Particularly robust
with IK10

M-POL

M-POL is the first SLV outdoor family that can be integrated into a DALI system. For this purpose, the character of the individual members can be modularly designed with different sizes, luminaire heads and lighting characteristics. Thanks to protection class IP65 and impact resistance rating IK10, the bollard luminaires are optimally protected everywhere. And connection is just as quick as it is easy with the connection box.



M-POL BOLLARD

● Anthracite

Material: Aluminium

| Version | Art.no. | Dimensions |
|---------------|----------------|------------------------|
| 30 | 1006379 | Ø: 12,4 cm, H: 23,4 cm |
| 60 Anthracite | 1006380 | Ø: 12,4 cm, H: 53,4 cm |
| 90 | 1006381 | Ø: 12,4 cm, H: 83,4 cm |



| Article | Art.no. | Dimensions |
|---|----------------|--------------------------------|
| Ground anchor <i>Stainless steel</i> | 1006382 | Ø: 10 cm, L: 20 cm |
| Connection Box <i>5-pole</i> | 1006453 | L: 18 cm, W: 6.3 cm, H: 3.3 cm |
| Connection Box <i>5-pole</i> | 228725 | Ø: 3.2 cm, L: 13 cm |
| T-connection box <i>3-pole</i> | 228726 | L: 11 cm, W: 6.4 cm, H: 3 cm |
| Junction box <i>3-pole, IP68</i> | 228730 | Ø: 2.7 cm, L: 11.5 cm |



M-POL LAMP HEADS

ON/OFF

220-240 V ~50/60 Hz | 500 mA
System output: 11 W

DALI

220-240 V ~50/60 Hz | 500 mA
System power: 19 W

● Anthracite

Material: Aluminium

| Variant | | Art.no. | Lumen | Kelvin | CRI | Dimensions |
|---------|--------|--------------------|----------------|----------------|-------------|------------|
| S | Clear | Anthracite, On/Off | 1006383 | 470 - 510 lm | 2700/3000 K | 90 |
| | | Anthracite, DALI | 1006389 | 890 - 950 lm | | |
| | Shader | Anthracite, On/Off | 1006387 | 285 - 310 lm | | |
| | | Anthracite, DALI | 1006393 | 520 - 550 lm | | |
| | Louver | Anthracite, On/Off | 1006385 | 145 - 155 lm | | |
| | | Anthracite, DALI | 1006391 | 260 - 270 lm | | |
| M | Clear | Anthracite, On/Off | 1006384 | 590 - 660 lm | 2700/3000 K | 90 |
| | | Anthracite, DALI | 1006390 | 1150 - 1230 lm | | |
| | Shader | Anthracite, On/Off | 1006388 | 420 - 460 lm | | |
| | | Anthracite, DALI | 1006394 | 820 - 870 lm | | |
| | Louver | Anthracite, On/Off | 1006386 | 190 - 210 lm | | |
| | | Anthracite, DALI | 1006392 | 350 - 370 lm | | |



Shader

Louver

Clear



Choose between
On/Off or DALI



CHOOSE YOUR M-POL SYSTEM

The right bollard luminaire in just a few steps - the modular M-POL system makes it possible. It combines three sizes and six luminaire heads with three lighting characteristics and two colour temperatures. Whether in high or flat form, with shaders for great light, homogeneous and diffused distribution or glare-free thanks to integrated louvres. Whether with 2700 or 3000 Kelvin, as On/Off version or DALI controllable. Configure your desired M-POL bollard luminaires and put outdoor ambience in the best light.

CHOOSE YOUR PREFERRED ...

- 1 Bollard (30, 60, 90)
- 2 Luminaire head (On/Off, DALI)
- 3 Luminaire head size (high, flat)
- 4 Light property (clear, shader, louver)
- 5 Colour temperature (2700, 3000 K)



READY!

LIGHT HEADS

M-POL S

Ø: 12,3 cm, H: 15,9 cm

M-POL M

Ø: 12,3 cm, H: 25,9 cm

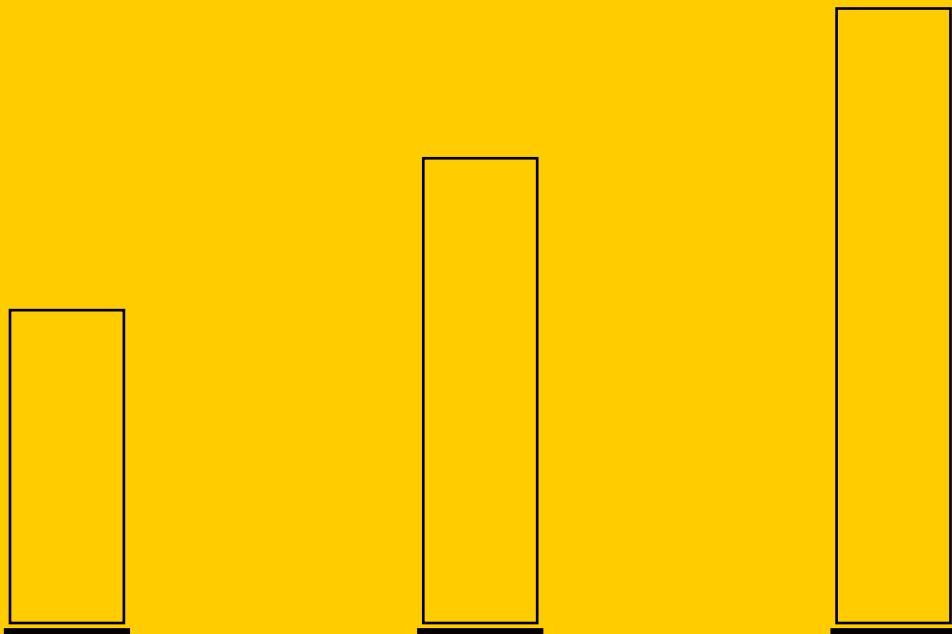
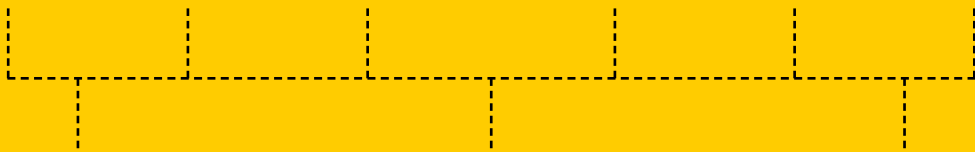
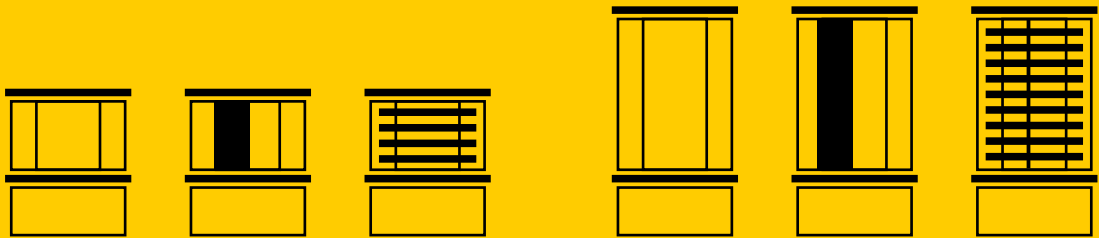

M-POL 30

Ø: 12,4 cm, H: 23,4 cm

M-POL 60

Ø: 12,4 cm, H: 53,4 cm

M-POL 90

Ø: 12,4 cm, H: 83,4 cm

BOLLARD



COMBINE



UNIVERSAL
DOWNLIGHT



Bezel in the colours
black, white,
chrome, gold



When purchasing a UNIVERSAL
DOWNLIGHT, the bezel is not included
in the delivery as standard

UNIVERSAL DOWNLIGHT

High-quality, modern, universally applicable: With its colour temperature adjustable via CCT switch (2700/3000/4000/6500 K), UNIVERSAL DL offers a high degree of flexibility. At the same time, the price of the fixed or swivelling downlight is in the best possible ratio to its quality. And thanks to the quick connector, installation is also done in no time.

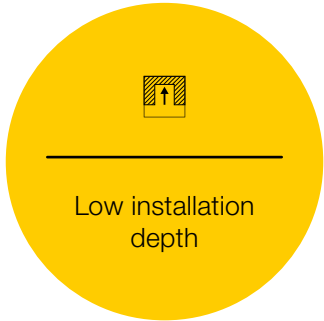

UNIVERSAL DOWNLIGHT

220-240 V ~50/60 Hz | 60/90 mA

System power: 5/8 W

Material thickness of mounting surface: 25 mm max.

● Black

Material: Steel

| Variant | Art.no. | Lumen | Kelvin | CRI | Dimensions | |
|---------|-------------|---------|--|----------------------------|------------|----------------------|
| DL | Black, Move | 1007090 | 410/560 lm 430/610 lm 470/680 lm | 2700 K 3000 K 4000 K | 90 | Ø: 8,5 cm, H: 6,1 cm |
| | Black | 1007095 | 440/640 lm | 6500 K | | |



● Black ○ White ● Chrome ● Gold

| Article | Art.no. | Dimensions |
|--------------------|---------------|------------|
| Front ring Move | Black, round | 1007091 |
| | White, round | 1007092 |
| | Chrome, round | 1007093 |
| | Gold, round | 1007094 |
| Bezel | Black, round | 1007096 |
| | White, round | 1007097 |
| | Chrome, round | 1007098 |
| | Gold, round | 1007099 |



DESIGN YOUR DOWNLIGHT

Unobtrusive and universally usable: the UNIVERSAL DOWNLIGHT as a rigid and swivelling version are recessed luminaires that produce a targeted light with their narrow beam angle of 36 degrees. Before installation, the light colour can be selected from a wide spectrum (2700/3000/4000/6500 K) via CCT switch. True-to-nature colour rendering is achieved with a CRI of over 90. The Quick Connector Box makes the downlight quick and easy to install. Complement your UNIVERSAL DOWNLIGHT with the separately available bezels, available in black, white, chrome or gold.

CHOOSE YOUR PREFERRED ...

- 1 Variant (rigid, swivel)
- 2 Bezel (black, white, chrome, gold)
- 3 Colour temperature (2700, 3000, 4000, 6500K)
- 4 Light output (5 W, 8 W)



READY!

UNIVERSAL DOWNLIGHT

UNIVERSAL DOWNLIGHT

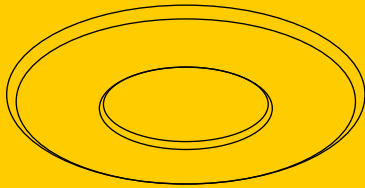

Available as rigid version

UNIVERSAL DOWNLIGHT MOVE

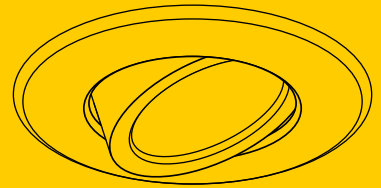

Available as swivel version

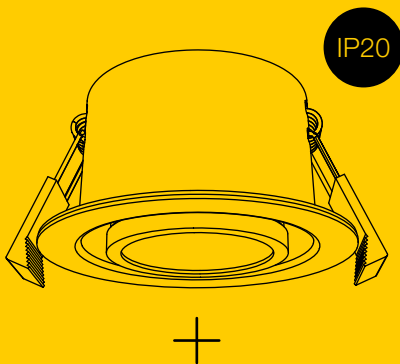

IP20

Easy installation by means of
quick-connect junction box

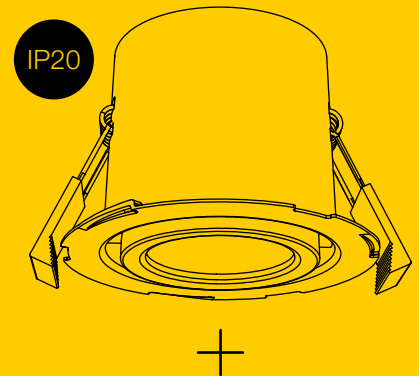

IP20

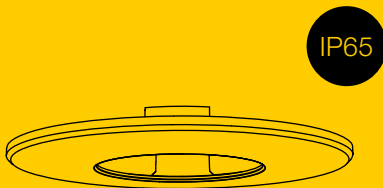

IP65

Interchangeable bezels in
black, white, chrome or gold

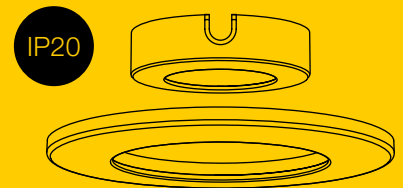

IP20

2700 K 3000 K 4000 K 6500 K

Switchable colour temperature

2700 K 3000 K 4000 K 6500 K

Switchable system power
5 W/8 W

High quality of light and colour rendering
thanks to LED with CRI90



MOON

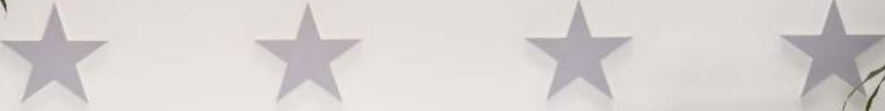



PANTILO

A crystal-clear highlight: the new oval shade version of the PANTILO pendant luminaire is not only available in chrome and copper, but also, like the other versions, in gold and sandblasted white. Real eye-catchers that can be combined with other lighting systems thanks to the open cable end.

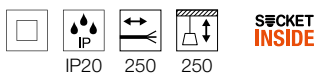

PANTILO PD

200-240 V ~50/60 Hz

Open cable end

Chrome
 Copper
 White
 Gold

Material: Aluminium/Glass



| Variant | Art.no. | Base | Watt | Dimensions |
|---------|---------|---------|-------|----------------------|
| 20 | Gold | 1 x E27 | <15 W | Ø: 20 cm, H: 21.3 cm |
| | White | | | |
| 28 | Gold | 1 x E27 | <15 W | Ø: 28 cm, H: 17.2 cm |
| | White | | | |
| | Chrome | | | |
| Oval | Copper | 1 x E27 | <15 W | Ø: 18 cm, H: 28.5 cm |
| | White | | | |
| | Gold | | | |



With special
lens for a sharper
light image

ENOLA OCULUS

Elegant and accurate at the same time: ENOLA OCULUS uses a special lens technology that makes it a sharply contoured accent lighting source. The wall and ceiling luminaire is protected outdoors by IP65. Via CCT switch, the light colour (3000/4000 K) can be adjusted before installation. In addition, the built-in light source with a CRI of over 90 convinces with a natural colour rendering.



ENOLA OCULUS

CL/WL SINGLE

220-240 V ~50/60 Hz | 500 mA
System power: 11 W

WL UP/DOWN

220-240 V ~50/60 Hz | 500 mA
System output: 20 W

● Anthracite

Material: Aluminium/Glass

| Variant | Art.no. | Lumen | Kelvin | CRI | Dimensions |
|------------------------|---------|----------------|-------------|-----|----------------------|
| CL Anthracite, single | 1006327 | 1000 - 1100 lm | 3000/4000 K | 90 | Ø: 10 cm, H: 12 cm |
| WL Anthracite, single | 1006328 | | | | Ø: 10 cm, H: 15,5 cm |
| WL anthracite, up/down | 1006329 | 940 - 1060 lm | | | Ø: 10 cm, H: 18 cm |



MANA

With its rust look, the MANA BASE with the new MANA RUSTY lampshade conjures up a unique, indirect lighting atmosphere. Thanks to the special FeCSi steel treatment, the typical patina only becomes more unique with time. The light colour is adjustable via CCT switch (2700/3000 K). And thanks to IP65, the wall luminaire, which can be used indoors as well as outdoors, is also optimally protected.

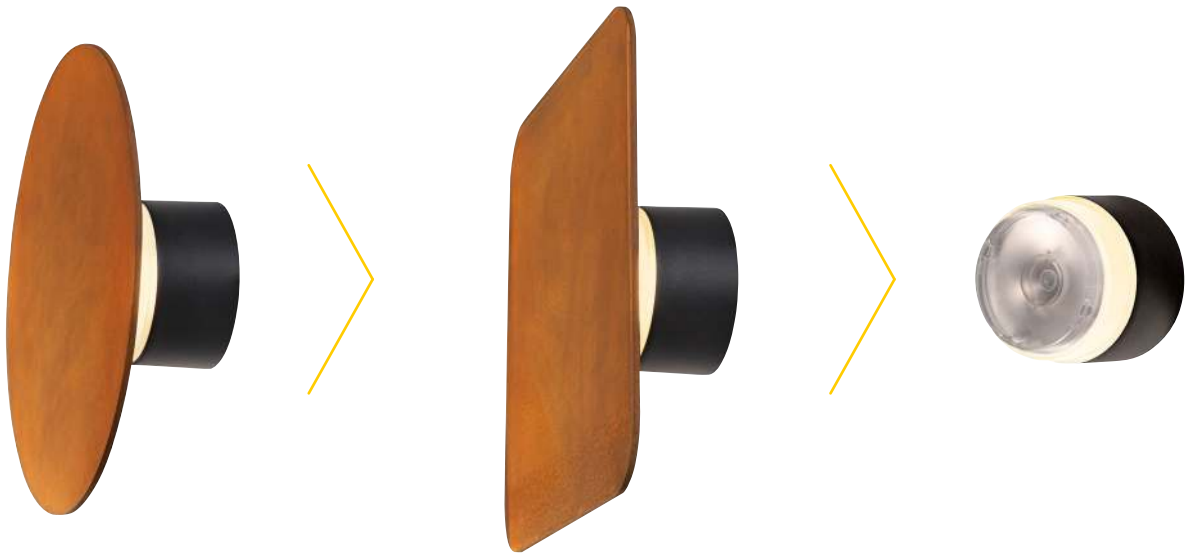

MANA BASE WL

220-240 V ~50/60 Hz | 350 mA
System power: 15 W

● Anthracite

Material: Aluminium/Polycarbonate (PC)

COMPLETE THE LOOK

Complement the MANA BASE with the new RUSTY MANA shades.

| Variant | Art.no. | Lumen | Kelvin | CRI | Dimensions |
|---------------|---------|------------|-------------|-----|-------------------|
| WL Anthracite | 1006319 | 800/820 lm | 2700/3000 K | 90 | Ø: 10 cm, H: 9 cm |



| Article | Item no. | Dimensions |
|------------|----------|-------------------------------|
| RUSTY MANA | 1006317 | L: 28 cm, W: 28 cm, H: 1,5 cm |
| Shade | 1006318 | Ø: 28 cm, H: 1,5 cm |



Different diffusers included for special lighting effects



MANA OUT WL

220-240 V ~50/60 Hz | 500 mA
System power: 11 W

● Grey

Material: Aluminium/Concrete

| Variant | Art.no. | Lumen | Kelvin | CRI | Dimensions |
|---------|---------|----------------------------|--------|-----|----------------------------------|
| WL Grey | 1003470 | Up: 325 lm Down: 325 lm | 3000 K | 80 | L: 18.2 cm, W: 10.3 cm, H: 16 cm |





CONCRETO

High-quality highlight made of the trend material concrete: CONCRETO sets new accents in the outdoor area. With its colour temperature of 3000 Kelvin, the table and floor lamp produces a warm white light that is extremely pleasant. In addition, it is protected against penetrating dirt and splash water with IP65.



Made of real concrete and flexible in use thanks to a 2 m connection cable.



SOCKET
INSIDE

IP65 IK05 200

CONCRETO FL

220-240 V ~50/60 Hz
IP44 safety plug

● Grey

Material: Concrete/Aluminium

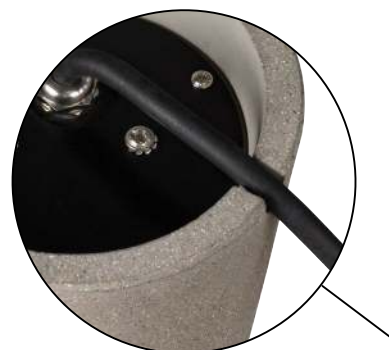

| Variant | Art.no. | Base | Illuminant | Watt | Dimensions |
|----------------|---------|----------|----------------|-------|------------------------------------|
| FL Grey, round | 1006408 | 1 x GU10 | Ø: 5,1 cm max. | <10 W | Ø: 12 cm, H: 11,7 cm |
| grey, angular | 1006409 | QPAR 51 | L: 6 cm | | L: 10,5 cm, W: 10,5 cm, H: 11,7 cm |



VANO WING

Ideal for illuminating vertical surfaces: Thanks to its wide beam angle and asymmetrical reflector, the VANO WING achieves a high level of illumination even at close distances. At the same time, the DALI-integratable warm white light (3000 K) shines particularly brightly. And thanks to IP65, the swivelling spotlight is also protected in all weathers.

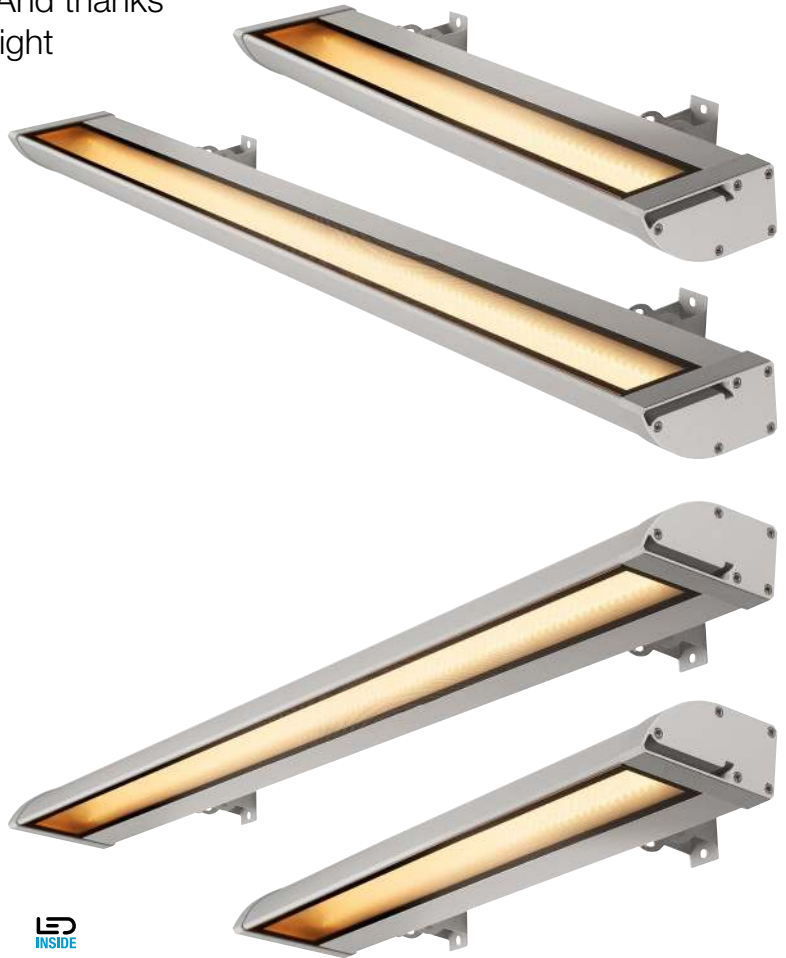

VANO WING

SP (SHORT)

220-240 V ~50/60 Hz | 500 mA
System output: 25 W

SP (LONG)

220-240 V ~50/60 Hz | 1050 mA
System power: 49 W

● Grey

Material: Aluminium/Glass

| Variant | Art.no. | Lumen | Kelvin | CRI | Dimensions |
|----------------|---------|---------|--------|-----|------------------------------------|
| SP Grey, short | 1006268 | 1400 lm | 3000 K | 80 | L: 63.5 cm, W: 20.5 cm, H: 6.5 cm |
| SP Grey, long | 1006270 | 3140 lm | | | L: 119.5 cm, W: 20.5 cm, H: 6.5 cm |



Honoured with the
German Design
Award 2022



ESKINA FRAME

New addition to the design-award-winning outdoor family: the luminaire heads of the ESKINA FRAME wall and ceiling luminaire can be swivelled through 320°. The light colour can be flexibly adjusted via CCT switch (3000/4000 K). Thanks to IP65, it is optimally protected. The only thing missing is simple installation, which is a matter of course with SLV.



ESKINA FRAME

CL SINGLE

220-240 V ~50/60 Hz | 350 mA
System power: 15 W

WL DOUBLE

220-240 V ~50/60 Hz | 700 mA
System power: 27 W

● Anthracite

Material: Aluminium/Glass



| Variant | Art.no. | Lumen | Kelvin | CRI | Dimensions |
|-----------------------|----------------|--------------|-------------|-----|-----------------------------------|
| CL Anthracite, single | 1006316 | 1100/1200 lm | 3000/4000 K | 80 | L: 13.3 cm, W: 12 cm, H: 13.3 cm |
| WL Anthracite, double | 1006314 | 2200/2400 lm | | | L: 24,5 cm, W: 17,1 cm, H: 7,3 cm |

EASY TO INSTALL

When we say „Easy to Install“, we mean well thought-out features for more efficiency. For you, this means: time-saving installation for fast project completion, clean work and satisfied customers.

Because efficiency always pays off, SLV luminaires are easy, quick and safe to install. With fixed mounting plates, hook-in luminaire heads, spring clamp connections, through-wiring, cable entries and other features, they offer decisive advantages: That you save time, effort and costs.

HOOK-IN LUMINAIRE HEADS.

With our ESKINA family, the luminaire head can be separated from the mounting plate fixed to the wall. This leaves both hands free to screw the luminaire on securely after it has been suspended via the integrated lug and the electrical connection via the spring-loaded terminal block.



1

MOUNTING ON THE WALL.

Screw the mounting plate to the wall with the fixing screws.

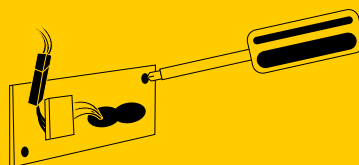

2

UNCOMPLICATED PLUGGING TOGETHER.

Connect the power supply connector to the LED luminaires.

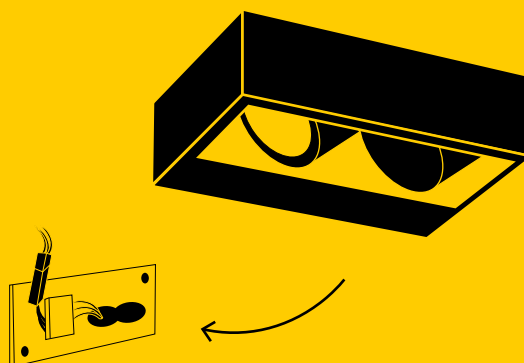

3

ASSEMBLE CLEANLY AND SECURELY.

Hook the luminaire into the practical guide groove of the mounting plate and screw the luminaire body to the mounting plate.



DONE!





OCULUS

Thanks to its special lens optics, OCULUS emits a sharply contoured beam of light in outstanding quality. Whether the wall luminaire is then directed upwards or downwards – the lighting mood can always be individually controlled thanks to the dim-to-warm function (2000 - 3000 K).

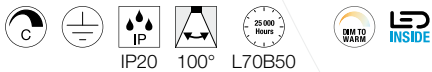

OCULUS WL SINGLE

220-240 V ~50/60 Hz | 350 mA
System power: 8.5 W

● Black ○ White

Material: Aluminium/Glass

| Variant | Art.no. | Lumen | Kelvin | CRI | Dimensions |
|----------|---------|-------------|---------------|-----|------------------|
| WL Black | 1006307 | 22 - 555 lm | 2000 - 3000 K | 90 | Ø: 9 cm, H: 8 cm |
| WL White | 1006308 | | | | |

DIM-TO-WARM

With the Dim-to-Warm function, the colour temperature and brightness of the luminaires can be adjusted. When dimmed down, the light changes from bright, cool to soft, warm.



S-TRACK

Makes the best technical and visual impression: the DALI-compatible 3-phase recessed track integrates harmoniously into the interior design and offers dimmable flexibility all along the line. Perfect for a small number of power outlets. And for lighting projects where individually switchable circuits are important.





S-TRACK 3-PHASE RECESSED TRACK

220-250 V ~50/60 Hz

Max. current: 16 A



Black



White

Material: Aluminium

| Variant | | Art.no. | Dimensions |
|---------|-------|----------------|----------------------|
| 1 m | Black | 1006511 | L: 100 cm, W: 5.6 cm |
| | White | 1006512 | |
| 2 m | Black | 1006513 | L: 200 cm, W: 5.6 cm |
| | White | 1006514 | |
| 3 m | Black | 1006515 | L: 300 cm, W: 5,6 cm |
| | White | 1006516 | |
| 4 m | Black | 1006517 | L: 400 cm, W: 5.6 cm |
| | White | 1006518 | |



Material: Polycarbonate (PC)

| Article | | Art.no. | Power | Dimensions |
|--|-------|----------------|-----------|-----------------------------------|
| Feeder <i>DALI</i> <i>Earth right</i> | Black | 1006519 | 16 A max. | L: 14.7 cm, W: 5.6 cm, H: 3.3 cm |
| | White | 1006520 | | |
| Feeder <i>DALI</i> <i>Earth left</i> | Black | 1006521 | 16 A max. | L: 14.7 cm, W: 5.6 cm, H: 3.3 cm |
| | White | 1006522 | | |
| L-connector <i>DALI</i> <i>Earth inside</i> | Black | 1006523 | 16 A max. | L: 13 cm, W: 13 cm, H: 3.3 cm |
| | White | 1006524 | | |
| L-connector <i>DALI</i> <i>Earth outside</i> | Black | 1006525 | 16 A max. | L: 13 cm, W: 13 cm, H: 3.3 cm |
| | White | 1006526 | | |
| T-connector <i>DALI</i> <i>Earth inside left</i> | Black | 1006527 | 16 A max. | L: 20.3 cm, W: 13 cm, H: 3.3 cm |
| | White | 1006528 | | |
| T-connector <i>DALI</i> <i>Earth outside right</i> | Black | 1006529 | 16 A max. | L: 20.3 cm, W: 13 cm, H: 3.3 cm |
| | White | 1006530 | | |
| T-connector <i>DALI</i> <i>Earth inside right</i> | Black | 1006531 | 16 A max. | L: 20.3 cm, W: 13 cm, H: 3.3 cm |
| | White | 1006532 | | |
| T-connector <i>DALI</i> <i>Earth outside left</i> | Black | 1006533 | 16 A max. | L: 20.3 cm, W: 13 cm, H: 3.3 cm |
| | White | 1006534 | | |
| X-connector <i>DALI</i> <i>Earth outside</i> | Black | 1006535 | 16 A max. | L: 20.3 cm, W: 20.3 cm, H: 3.3 cm |
| | White | 1006536 | | |
| Connector <i>DALI</i> | Black | 1006537 | 16 A max. | L: 20.3 cm, W: 56 cm, H: 3.3 cm |
| | White | 1006538 | | |
| End cap | Black | 1006539 | | L: 4.79 cm, W: 5.6 cm |
| | White | 1006540 | | |





DESIGN YOUR RAIL SYSTEM

Professionally positioned: Especially where there is a lot to see, well-designed lighting is essential. 3-phase high-voltage tracks are therefore ideal for shops and exhibition stands. With the matching SLV luminaires, they create a perfect ambience and put products and exhibits in the right light. 1-phase high-voltage tracks are particularly suitable for private households and bathe your living spaces in atmospheric light. Thanks to the holes in the profile, the aluminium tracks can be quickly and easily mounted on walls or ceilings. You can choose between a recessed version and a surface-mounted version, which are available in several colours.

CHOOSE YOUR PREFERRED ...

- 1 Track (S-TRACK, EUTRAC, 1-phase system)
- 2 Mounting type (recessed/surface-mounted track)
- 3 Luminaire
- 4 Design options



DONE!

TRACK SYSTEMS

S-TRACK
3-phase system

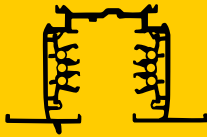

EUTRAC
3-phase system

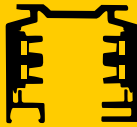

1-PHASE SYSTEM



Built-in rail



Surface-mounted
track



Ceiling



Wall



Pendant

Mounting options

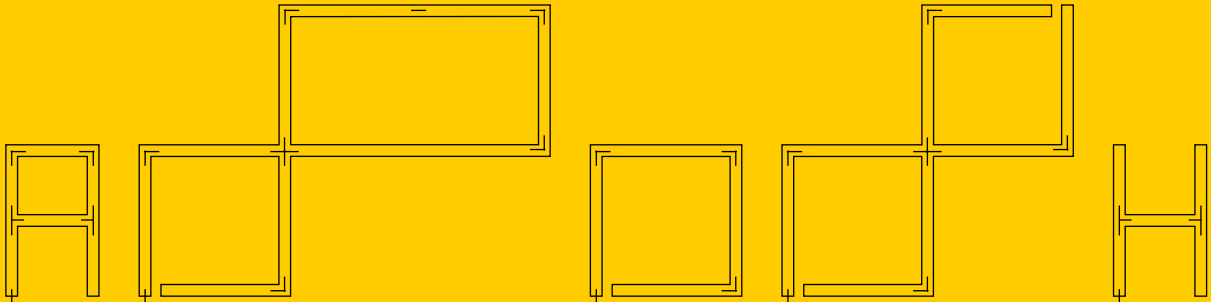

Different design options individually
matched to your room

Also use our track configurator at slv.com



WORKLIGHT

WORKLIGHT now also does a good job in silver. The luminaire produces glare-free (UGR19) and activating light (4000 K) that is ideal for being productive. And while the pendant luminaire can be integrated into a DALI system, the motion sensor, daylight control and dimmability round off the functionality of the table and floor version.

**NEW
VARIANT**

The new colour silver complements our WORKLIGHT family.

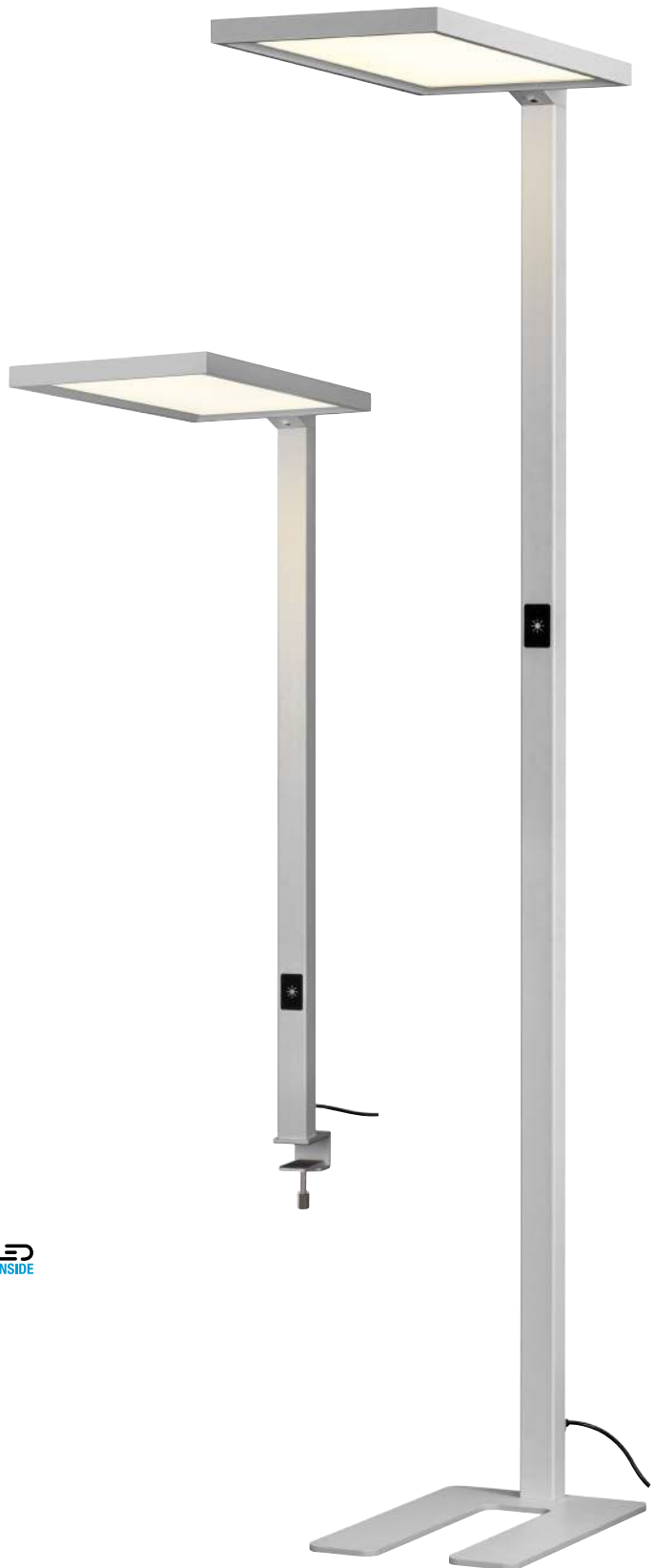
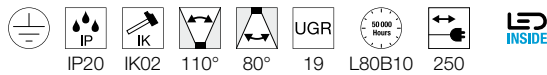

WORKLIGHT FL/TL

200-240 V ~50/60 Hz | 2000 mA

System power: 79 W

● Silver

Material: Aluminium

| Variant | Art.no. | Lumen | Kelvin | CRI | Dimensions |
|---------|----------------|---------------|--------|-----|------------------------------|
| FL | 1006343 | Up: 3800 lm | 4000 K | 80 | L: 69.2 cm, W: 31; H: 195 cm |
| TL | 1006344 | Down: 3800 lm | 4000 K | 80 | L: 69.2 cm, W: 31; H: 120 cm |

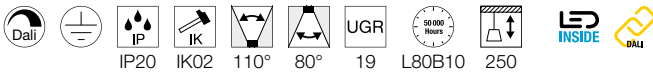
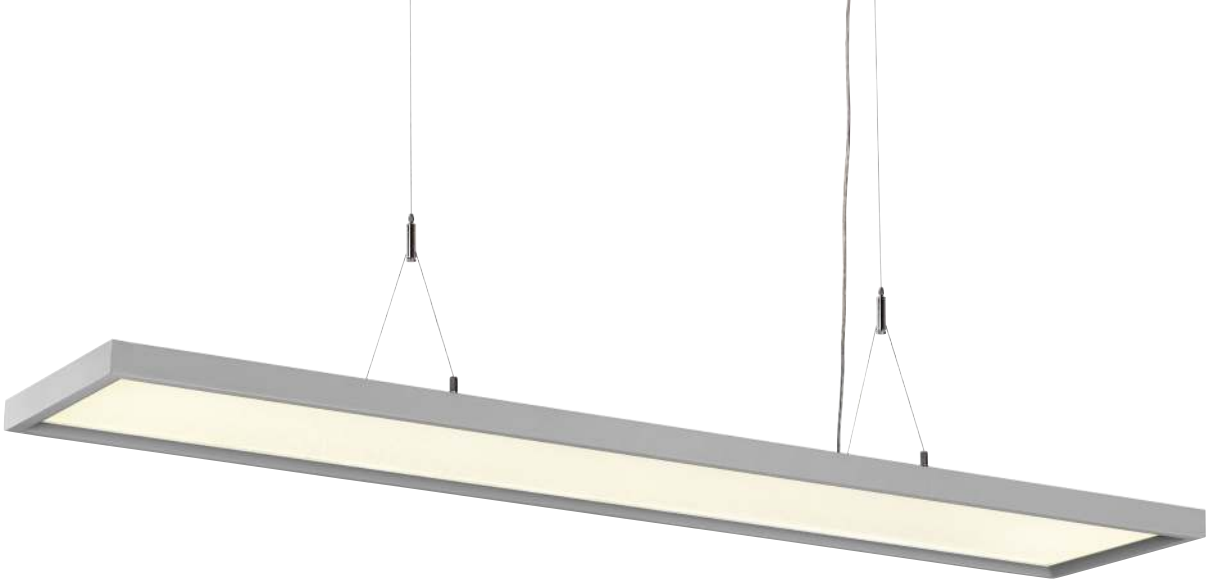

**NEW
VARIANT**

The new colour
silver completes
our WORKLIGHT
family

WORKLIGHT PD

200-240 V ~50/60 Hz | 1550 mA
System power: 57 W

● Silver

Material: Aluminium

| Variant | Art.no. | Lumen | Kelvin | CRI | Dimensions |
|-----------------|----------------|------------------------------|--------|-----|------------------------------|
| PD silver, DALI | 1006345 | Up: 2000 lm Down: 3000 lm | 4000 K | 80 | L: 69.2 cm, W: 31; H: 195 cm |

Our WORKLIGHT family is also
available in black and white:



1005395

1005396

1005390

1005391

1005392

1005394



NEW ACCESSORIES

PARA DOME

This new accessory for our PARA DOME pendant luminaire is ideal for technical, industrial applications. The lampshade made of aluminium is also fully convincing in terms of quality.



PARA DOME SHADE

 Black/Gold

Material: Aluminium

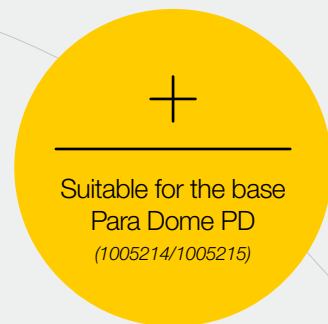

Suitable for the base
Para Dome PD
(1005214/1005215)

Variant

shade black/gold

Art.no.

1006410

Dimensions

Ø: 30,8 cm, H: 20,6 cm

FITU

The FITU ceiling rose is now also available in gold. Available as a surface-mounted or recessed version, it can be combined with a wide range of pendant luminaires.

FITU CEILING ROSE

● Gold

Material: Aluminium



| Variant | Art.no. | Power | Dimensions |
|--------------|-----------------------|-----------|----------------------|
| Ceiling rose | Gold, surface-mounted | max. 16 A | Ø: 9 cm, H: 2.6 cm |
| | Gold, built-in | | Ø: 8,5 cm, H: 3,3 cm |

FLOODI

Now add the new matching sensor to your FLOODI Outdoor luminaires: With a range between 5 and 10 m and a lighting duration between 10 sec. and 7 min., your Floodi Outdoor luminaire can be individually adjusted. The sensitivity of the sensor can be individually adjusted between 10 - 2000 lux.

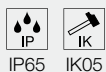

FLOODI SENSOR

● Black

Material: Polycarbonate (PC)

| Variant | Art.no. | Dimensions |
|---------|---------|---------------------------------|
| Sensor | 1006326 | W: 4.4 cm, H: 6.9 cm, D: 5.7 cm |



TREK
THE BEST IS NOT IN THE ROAD

acer

REVERBY
PERFORMANCE BAR

REVERBY
PERFORMANCE BAR

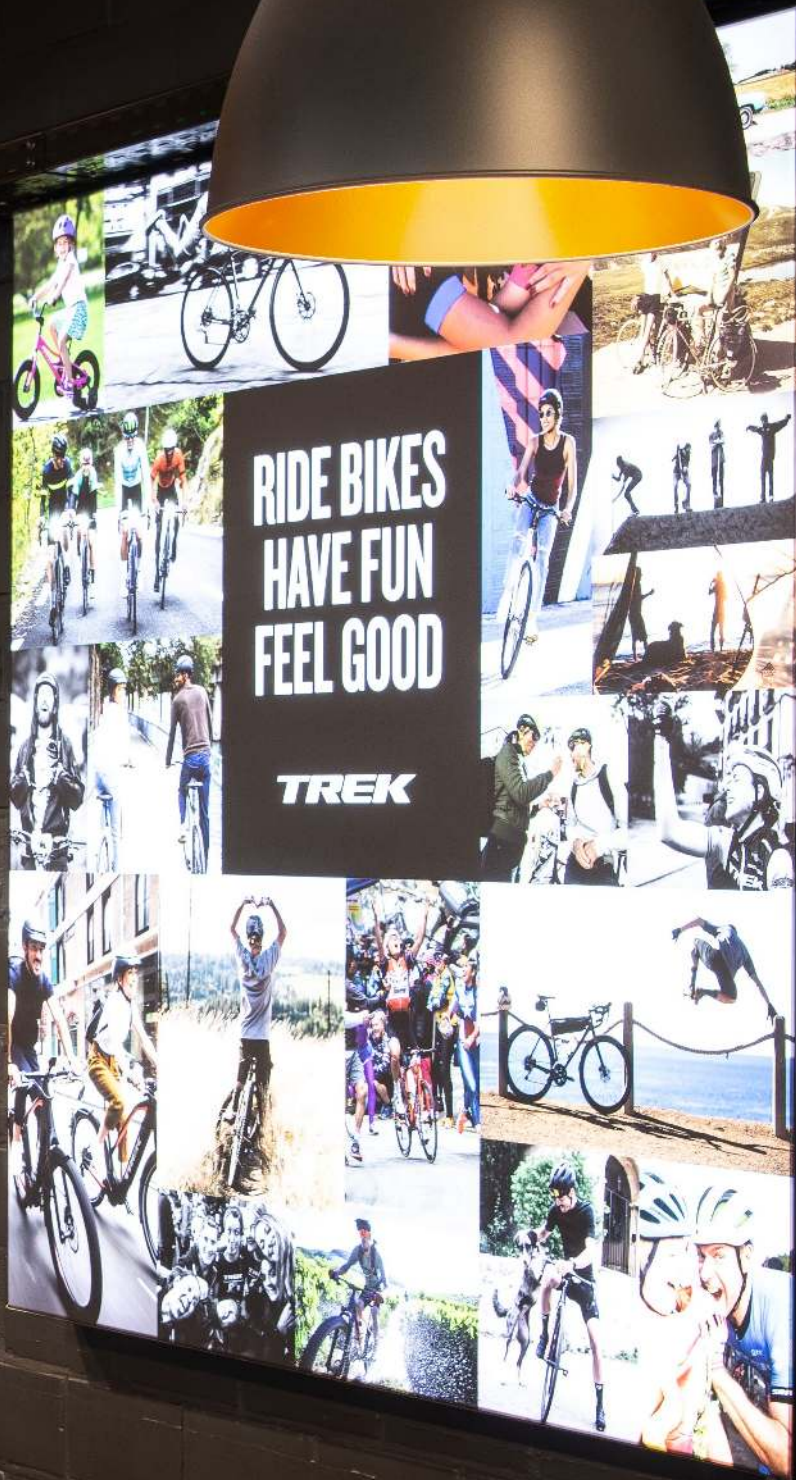

**RIDE BIKES
HAVE FUN
FEEL GOOD**

TREK



ONZE MISSIE
Wi
KL
do

COLOUR EXPLANATION



Anthracite

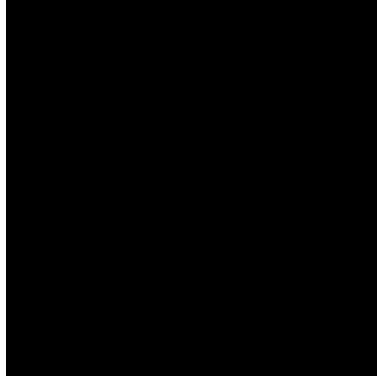

Black



Grey

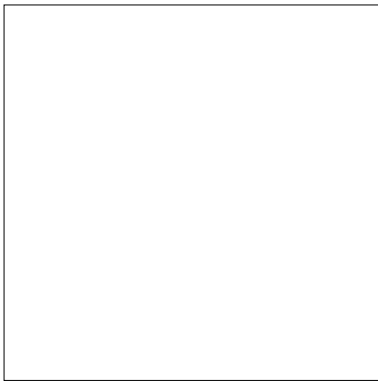

White



Chrome



Silver



Gold



Brass



Copper

SYMBOL EXPLANATION



Dimmable with:

- **C** = Phase cut-off dimmer
- **SWITCH** = Switch/button or touch control on the luminaire
- **DALI** = DALI bus system



Connected Lighting:

Identifies smart products that use DALI protocols.



Protection classes:

- Protection class I / protective earth
- Protection class II / protection by double or reinforced insulation



IP protection class:

Indicates the suitability of electrical equipment for various environmental conditions.



IK impact resistance grade:

The IK impact resistance degree is a measure of the resistance of enclosures of electrical equipment to mechanical stress, especially impact stress.



Half-radiation angle:

Describes the angle of radiation in degrees. The smaller the angle, the more the light is bundled.



Unified Glare Rating:

The lower the UGR value, the lower the psychological glare.

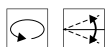

Rotating and swivelling range in degrees:

- Rotating range
- Swivel range



Luminous flux maintenance:

Describes by how much the luminous flux of an LED decreases in the specified time period.

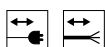

- Mains cable length in cm
- Supply cable length in cm (with open cable end)



Pendant cable length in cm



Through-wiring possible



CCT switch:

By means of a built-in CCT switch, the light colour can be changed from 2700 K, 3000 K, 4000 K to 6500 K during installation.



Dim-to-Warm:

Dimming changes the light colour from cool white to warm white.



- Products with built-in LEDs
- Products with lamp socket



Indication of installation depth









A large number of the products presented in this brochure are protected by trademarks, registered designs, utility models or patents. Any infringement of these property rights or any use of text and layout design or copyrighted images without our permission will be prosecuted. The illustrations and information contained in this brochure are for illustrative purposes only and are non-binding in terms of colour, shape, design and technical data. All product descriptions/information are therefore subject to change and errors excepted.

All products in our range are subject to strict quality assurance and comply with the generally applicable standards. This brochure contains a general range of products and is not designed to be country-specific. Any deviations from country-specific specifications must be clarified before ordering. SLV is not liable for any deviating technical standards. All weights and lengths are given in kg or cm unless otherwise stated. Subject to technical changes!

SLV is entitled to adjust the respective price list to changing market conditions, in the event of significant changes in procurement costs, changes in sales tax or procurement prices.

SLV GmbH | Daimlerstraße 21-23, 52531 Uebach-Palenberg, Germany, +49 (0) 2451 4833-333, info@slv.de
SLV Austria | +49 (2451) 4833 355, export@slv.de
SLV Belgium | Herentalsebaan 429, B-2160 Wommelgem, +32 (0) 3/385 30 08, info@slv.be
SLV Nordics | Flade Engvej 4, 9900 Frederikshavn, Denmark, +45 9310 7474, info@nordics.slv.com
SLV France | Zac du Martelet, 88, rue Henri Dépaigneux, F-69400 Limas, +33 4 74 02 71 20, info@slv.fr
SLV LIGHTING UK LTD | Unit E Chiltern Park, Boscombe Road, Dunstable, LU5 5LT, +44 (0)203 968 11 00, sales@uk.slv.com
SLV Italia S.r.l. | Via Lecco, 19/D, 23896 Bevera di Sirtori (LC), +39 039 5983575, info@slvitalia.it
SLV Nederland | Kazernestraat 19, 5928 NL Venlo, +31 773204343, info@slv.nl
SLV Norway AS | Vangsveien 10, 1814 Askim, +47 48225500, post@slvnorway.no
SLV Poland | ul. Poznańska 356, 05-850 Ożarów Maz., Polska, (0048 22) 722-49-75, slv@slv.pl
SLV Portugal | R. Margarida de Abreu, no13 – Lj2, 1900-314 Lisboa, +351 210 185 961, info@pt.slv.com
SLV Swiss SA | Route du Bey 6 Box 1-4, Z.I. La Jonnaire, CH-1847 Rennaz, +41 218113232, info@slv-swiss.ch
SLV d.o.o | Barjanska cesta 50, SI-1000 Ljubljana, +386 1 2009 730, info@slv.si
SLV Spain | Antic Camí Ral Valencia, 38, L17, 08860 Castelldefels, Barcelona, 931 168 161, info@slv.es
SLV Czech s.r.o. | V Sedlci 28/17, CZ-160 00 Praha 6, +420 739 282 151, info@cz.slv.com

slv.com